

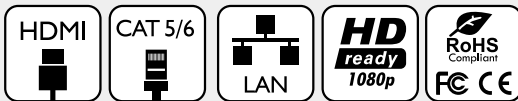

Control Your Video

VIDEO WALLS VIDEO PROCESSORS
VIDEO MATRIX SWITCHES
EXTENDERS SPLITTERS WIRELESS
CABLES & ACCESSORIES

HDMI LAN Extender up to 120M over Single CAT5/6 with IR Support



Model #: HDM-C6IPX-SET

© 2015 Avenview Inc. All rights reserved.

The contents of this document are provided in connection with Avenview Inc. ("Avenview") products. Avenview makes no representations or warranties with respect to the accuracy or completeness of the contents of this publication and reserves the right to make changes to specifications and product descriptions at any time without notice. No license, whether express, implied, or otherwise, to any intellectual property rights is granted by this publication. Except as set forth in Avenview Standard Terms and Conditions of Sale, Avenview assumes no liability whatsoever, and disclaims any express or implied warranty, relating to its products of Avenview Inc. is strictly prohibited.

Product Application & Market Sectors



Corporate



House Of Worship



Military



Residential



Education



Industrial



Medical



Aviation



TABLE OF CONTENTS

1.	GETTING STARTED	1
1.1	IMPORTANT SAFEGUARDS.....	1
1.2	SAFETY INSTRUCTIONS	1
1.3	REGULATORY NOTICES FEDERAL COMMUNICATIONS COMMISSION (FCC)	2
2.	INTRODUCTION	3
2.1	PACKAGE CONTENTS	4
2.2	BEFORE INSTALLATION.....	4
2.2.1	APPLICATION DIAGRAM.....	5
2.2.2	APPLICATION DIAGRAM.....	6
2.3	DEVICE DESCRIPTION & LAYOUT	7
2.3.1	Front Panel & Rear Panel (Transmitter, HDM-C6IPX-S).....	7
2.3.2	Front Panel & Rear Panel (Receiver, HDM-C6IPX-R).....	7
2.4	IR CONTROL DECRPTION, HDM-C6IPX-SET).....	8
3.	INSTALLATION.....	9
4.	GENERAL TROUBLESHOOTING.....	9
5.	SPECIFICATIONS	10
6.	PIN & WIRING STANDARDDEFINITION.....	11



SECTION I: GETTING STARTED

I.1 IMPORTANT SAFEGUARDS

Please read all of these instructions carefully before you use the device. Save this manual for future reference.

What the warranty does not cover

- Any product, on which the serial number has been defaced, modified or removed.
- Damage, deterioration or malfunction resulting from:
 - Accident, misuse, neglect, fire, water, lightning, or other acts of nature, unauthorized product modification, or failure to follow instructions supplied with the product.
 - Repair or attempted repair by anyone not authorized by us.
 - Any damage of the product due to shipment.
 - Removal or installation of the product.
 - Causes external to the product, such as electric power fluctuation or failure.
 - Use of supplies or parts not meeting our specifications.
 - Normal wear and tear.
 - Any other causes which does not relate to a product defect.
- Removal, installation, and set-up service charges.

I.2 SAFETY INSTRUCTIONS

The Avenview HDM-C6IPX-SET, HDMI Extender has been tested for conformity to safety regulations and requirements, and has been certified for international use. However, like all electronic equipment's, the HDM-C6IPX-SET should be used with care. Read the following safety instructions to protect yourself from possible injury and to minimize the risk of damage to the unit.



- ⚠ Do not dismantle the housing or modify the module.
- ⚠ Dismantling the housing or modifying the module may result in electrical shock or burn.
- ⚠ Refer all servicing to qualified service personnel.
- ⚠ Do not attempt to service this product yourself as opening or removing housing may expose you to dangerous voltage or other hazards
- ⚠ Keep the module away from liquids.
- ⚠ Spillage into the housing may result in fire, electrical shock, or equipment damage. If an object or liquid falls or spills on to the housing, unplug the module immediately.
- ⚠ Have the module checked by a qualified service engineer before using it again.
- ⚠ Do not use liquid or aerosol cleaners to clean this unit. Always unplug the power to the device before cleaning.



1.3 REGULATORY NOTICES FEDERAL COMMUNICATIONS COMMISSION (FCC)

This equipment has been tested and found to comply with Part 15 of the FCC rules. These limits are designed to provide reasonable protection against harmful interference in a residential installation.

Any changes or modifications made to this equipment may void the user's authority to operate this equipment.

Warning symbols	Description
	<p>ONLY USE THE PROVIDED POWER CABLE OR POWER ADAPTER SUPPLIED. DO NOT TAMPER WITH THE ELECTRICAL PARTS. THIS MAY RESULT IN ELECTRICAL SHOCK OR BURN.</p>
	<p>DO NOT TAMPER WITH THE UNIT. DOING SO WILL VOID THE WARRANTY AND CONTINUED USE OF THE PRODUCT.</p>
	<p>THE VIDEO BOARDS ARE VERY SENSITIVE TO STATIC. PLEASE ENSURE IF RACK MOUNTED OR INSTALLED ON A SURFACE, IT SHOULD BE IN A GROUNDED ENVIROMENT.</p>
	<p>⚠ WARNING</p> <p>Read & understand user guide before using this device.</p> <p>Failure to follow the proper installation instructions could result in damage to the product and preventing expected results.</p>



2. INTRODUCTION







HDM-C6IPX-SET, HDMI extender set is an upgraded version of Avenview's popular HDM-C6IP-SET designed to provide an extra distance, extra IR support and the main difference it is network friendly - can be added to your existing network. Having a few years experience with HDMI over IP we have engineered a newer chipset providing extra PPI in resolution and lower bandwidth. So the user can extend any HD display with the resolutions of 1080p/60Hz up to 394 feet (120 meters) away from your HDMI or DVI-D source. Thanks to the use of the TCP/IP protocol, you can transfer your high-definition video over any existing TCP/IP network. See below three examples:

- A:** The Tx and Rx units can extend 120 meters over a single CAT5/6 cable connection point to point.
- B:** The Tx can be connected to a Gigabit switch to establish a IP address therefore sending 1080p video signals to multiple Rx connected to the Gigabit switch and the HDMI displays.
- C:** Multiple Tx's can be connected to a Managed Gigabit switch with VLAN/IGMP support therefore sending 1080p video signals to Rx connected to the Gigabit switch to show different sources on the HDMI displays.
 - Extends HDMI up to 120m over single CAT5E/6
 - Supports HDMI, EDID, Support HDCP
 - Supports resolution HDTV / 1080Pp/60Hz, Vesa (1920 x 1080)
 - Supporting the point to point transmission function currently which can be expanded to the multi-point to point transmission function.
 - Requires a managed Gigabit switch with VLAN/IGMP support to have a solution with multiple sources (Transmitters). Standard Gigabit switch can only support one transmitter.
 - The managed switch must support port based IEEE 802.1Q VLAN, IGMP, and to allow duplicate IP addresses across the VLAN domains.
 - Each VLAN acts as independent HDMI over IP Channel on the network.
 - Number of Tx and Rx that can be used is dependent on bandwidth of the switch (Recommended Gigabit switch 10/1000).
 - Unmanaged switches can be cascaded up to 3 layer network, allowing the farthest display to be located up to 394 meters away from the source device. Each receiver can be located up to 120 meters away from each switch.
 - Uses H.264 technology to process image compression on a fixed bandwidth.



2.1 PACKAGE CONTENTS

Before you start the installation of HDM-C6IPX-SET, please check the A. STANDARD package contents.

1	HDMI IPX TRANSMITTER	X 1	
2	HDMI IPX RECEIVER	X 1	
3	IR EXTENDER	X 1	
4	IR BLASTER	X 1	
5	POWER ADAPTER (5VDC)	X 2	
6	Mounting Bracket		
7	USER'S MANUAL	X 1	

2.2 BEFORE INSTALLATION

- Put the product in an even and stable location. If the product falls down or drops, it may cause an injury or malfunction.
- Don't place the product in too high temperature (over 50°C), too low temperature (under 0°C) or high humidity.
- Use the DC power adapter with correct specifications. If inappropriate power supply is used then it may cause a fire.



HDM-C6IPX-SET

1080p = 90m (295 feet) CAT5e
 1080p = 120m (394 feet) CAT6

CABLE INDEX

- INPUT/OUTPUT
- CAT-5e / CAT-6
- IR CONTROL

HDMI Monitor



Application Diagram 1

POINT TO POINT

HDM-C6IPX-R RECEIVER-RX

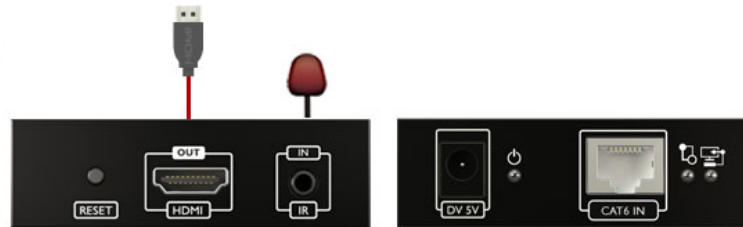

RECEIVER LOCATION 120m (394ft) AWAY

HDM-C6IPX-S SENDER-TX

SENDER LOCATION CONNECTED AT SOURCE

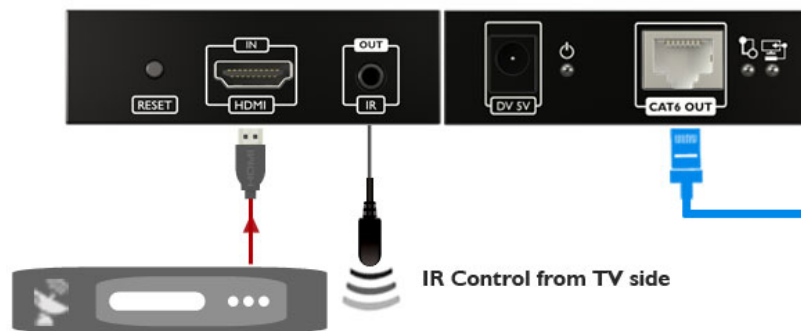

HDMI Source

IR Control from TV side



HDM-C6IPX-SET

CABLE INDEX

■ INPUT/OUTPUT

■ CAT5E/6

■ IR CONTROL

HDM-C6IPX-R

Application Diagram 2
LAN/SWITCH CONNECTION

1080p = 100m (295 feet) CAT5e
1080p = 120m (394 feet) CAT6

Multiple HDMI Monitor

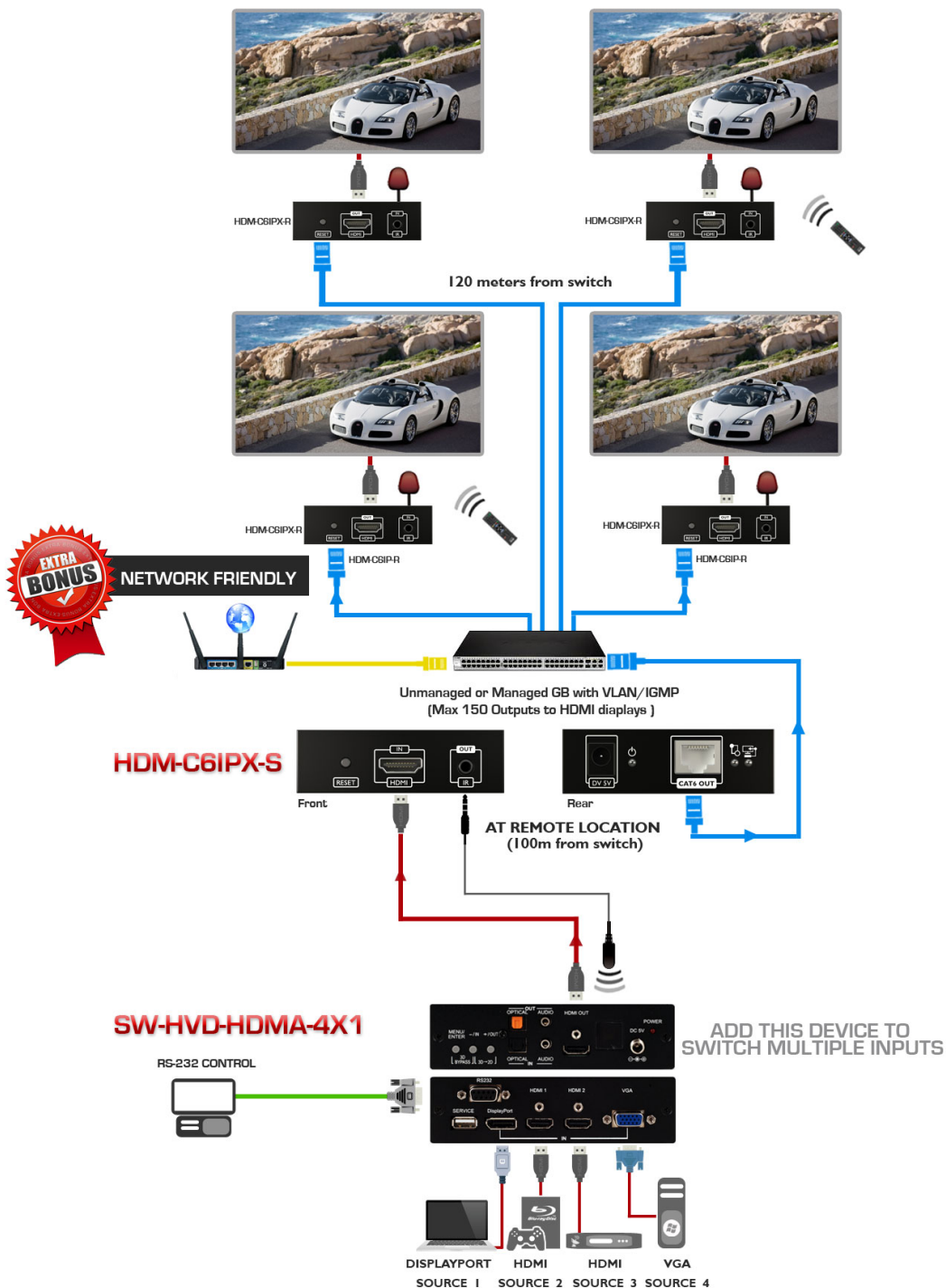

2.3 DEVICE DESCRIPTION & LAYOUT

This product is dUWU[YX UjUgYk \]W]bW XYga Transmitter and a Receiver.

2.3.1 Front Panel & Rear Panel (Transmitter, HDM-C6IPL -S)



1 +5V DC: Connect to the 5V DC power supply Power LED will light BLUE .	2 CAT5E/6 OUT: Plug in a Cat-5E/6 cable to link and send data (video and audio) to the Receiver unit or network switch.
3 DATA LED: When data is transmitting from the source the led will continuously flash YELLOW .	4 LINK LED: When connected to RX or network switch the LED will light GREEN .
5 RESET: To rest the unit when no link is established	6 HDMI IN: Connect to HDMI source Max 35ft via HDMI Cable
7 IR: Plug the IR Blaster cable for IR signal being recieved. Place IR Blaster within direct site of the device being controlled	

2.3.2 Front Panel & Rear Panel (Receiver, HDM-C6IPL -R)



1 +5V DC: Connect to the 5V DC power supply Power LED will light BLUE .	2 CAT5E/6 OUT: Plug in a Cat-5E/6 cable to link and receive data (video and audio) to a network switch.
3 DATA LED: When data is transmitting from the source the led will continuously flash YELLOW .	4 LINK LED: When connected to RX or network switch the LED will light GREEN .
5 RESET: To rest the unit when no link is established	6 HDMI OUT: Connect to HDMI display Max 35ft via HDMI Cable
7 IR IN: Plug the IR Extender cable for IR signal being received. Place IR Extender within direct line of site with the IR Remote.	

Important Please do not connect the HDM-C6IPX-SET to a POE network switch this will damage and the units will be come non functional.



2.4 IR CABLE DESCRIPTION

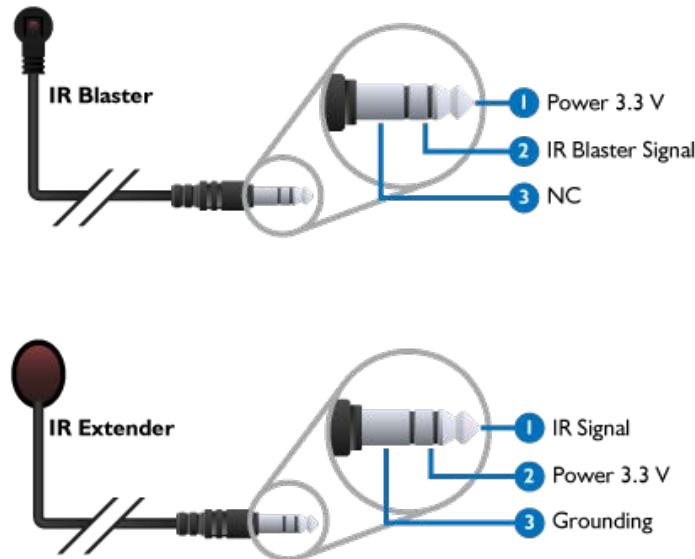

IR Sockets

-- **IR OUT** -IR BLASTER: plug in the IR blaster to the HDMC6IPX-S to emit all IR command signals received from the IR Extender plugged into the Rx (Monitor Side) to control the devices corresponding to the IR signals. Example: Set Top Box or DVD player (**The Source**).

-- **IR IN** - IR EXTENDER: plug in the IR Extender into the (RX) Receiver (Monitor Side) to receive all IR command signals from the IR remote controls of the corresponding source. Example: Set Top Box or DVD player (**IR Remote Control**).

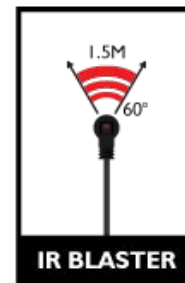
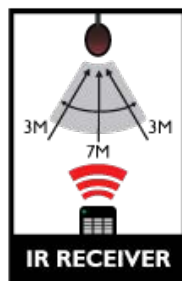

Important IR signals can be affected by very bright fluorescent light and also EMI Interference on the cables so be aware of where you place and position your IR cables. Please follow these instructions for best results.



3. INSTALLATION

Please ensure all the package contents are all received before proceeding.

To setup Avenview HDM-C6IPX-SET follow these steps for connecting to a device:

1. Connect your HDMI source (such as a Blu-ray Disc player) to Transmitter (HDM-C6IPX-S).
2. Connect your HDMI display (such as a LCD TV) to the receiving unit HDM-C6IPX-R.
3. Connect your CAT-5E/6 follow the standards of TIA-568BLAN cable between the transmitting and receiving units.
4. Make sure CAT-5E/6 LAN cable is tightly connected and not loose.
5. Plug in 5V DC power cord to the power jack of the transmitting unit HDM-C6IPX-S
6. Plug in 5V DC power cord to the power jack of the receiving unit HDM-C6IPX-R.

4. GENERAL TROUBLESHOOTING

PROBLEM	POSSIBLE SOLUTION
NO IMAGE	<ul style="list-style-type: none">• Check if connection to the source and the display are correct.• Ensure that display device supports 480p, 720p and 1080p resolution
SCREEN DEFECTS APPEAR	<ul style="list-style-type: none">• Check the DVI and HDMI connection
DATA TRANSMISSION LIGHT FLASHING SLOW	<ul style="list-style-type: none">• Check both units and make sure the TX and RX are not Reversed• Check the source device is powered ON
DATA TRANSMISSION LIGHT FLASHING FAST/NO IMAGE	<ul style="list-style-type: none">• Check Graphics card on PC/HD Player. This product supports up to 1080p (1920x1080) resolution.
NO LIGHT ON DATA TRANSMISSION	<ul style="list-style-type: none">• Check Network cable only use TIA-568B Standard• Network cable run is out of range



5. SPECIFICATIONS

ITEM	DESCRIPTION	
UNITS	HDM-C6IPX-S	HDM-C6IPX-R
UNIT DESCRIPTION	HDMI Transmitter	HDMI Receiver
HDMI COMPLIANCE	Full HD	
HDCP COMPLIANCE	Yes	
VIDEO BANDWIDTH	H.264 technology to process image compressing GIGABIT (10/1000) OVER LAN	
SUPPORTED RESOLUTIONS	480i@60Hz, 480p@60Hz, 576i@50Hz, 576p@50Hz, 720p@50/60Hz, 1080i@50/60Hz, 1080p@50/60Hz	
RESOLUTION AND DISTANCE (24-BIT)	Full HD: (1080p)-120meter (394feet) (CAT6)	
AUDIO SUPPORT	Surround Sound (up to 7.1 Ch) or Stereo Digital Audio	
IR PASS-THRU	Supports 20~60KHz IR devices	
RS-232 SUPPORT	NO	
INPUT	1x HDMI	1x RJ45, 1x IR IN
OUTPUT	1x RJ45, 1x IR Out	1x HDMI
HDMI CONNECTOR	Type A (19 pin female)	
RJ45 CONNECTOR	WE/SS 8P8C with 2 LED indicators	
POWER ADAPTER	2 X DC 5V/1A	
POWER CONSUMPTION	3W Max (each)	
DIMENSION L X W X H	3.8" x 3.7" x0.9"	
WEIGHT	0.3 lbs	

Environmental

OPERATING TEMPERATURE	32° ~ 140°F (0° to 60°C)
STORAGE TEMPERATURE	-4° ~ 140°F (-20° ~ 60°C)
RELATIVE HUMIDITY	20~90% RH.(no condensation)

PERFORMANCE GUIDE FOR HDMI OVER CATEGORY CABLE TRANSMISSION

PERFORMANCE RATING		TYPE OF CATEGORY CABLE		
WIRING	SHIELDING	CAT5	CAT5E	CAT6
SOLID	UNSHIELDED (UTP)	★★★	★★★★	★★★★★
	SHIELDED (STP)	★★★	★★★	★★★★★
STRANDED	UNSHIELDED (UTP)	★	★★	★★
	SHIELDED (STP)	★	★	★★
TERMINATION		PLEASE USE EIA/TIA-568-B TERMINATION (T568B) AT ANY TIME		



6. PIN & WIRING STANDARD DEFINITION

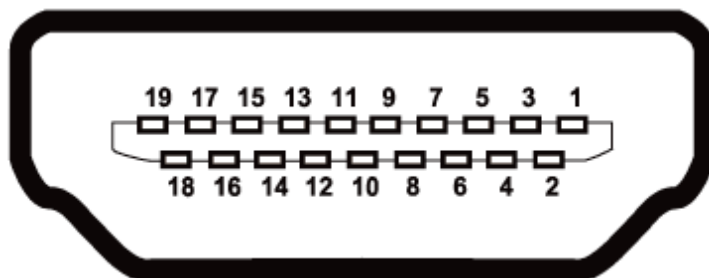

TYPE A (RECEPTACLE) HDMI

Pin 1	TMDS Data2+	Pin 11	TMDS Clock Shield
Pin 2	TMDS Data2 Shield	Pin 12	TMDS Clock-
Pin 3	TMDS Data2-	Pin 13	CEC
Pin 4	TMDS Data1 +	Pin 14	Reserved (N.C. on device)
Pin 5	TMDS Data1 Shield	Pin 15	SCL
Pin 6	TMDS Data1-	Pin 16	SDA
Pin 7	TMDS Data0+	Pin 17	DDC/CEC Ground
Pin 8	TMDS Data0 Shield	Pin 18	+5V Power
Pin 9	TMDS Data0-	Pin 19	Hot Plug Detect
Pin 10	TMDS Clock+		

CAT5E/6 WIRING STANDARD

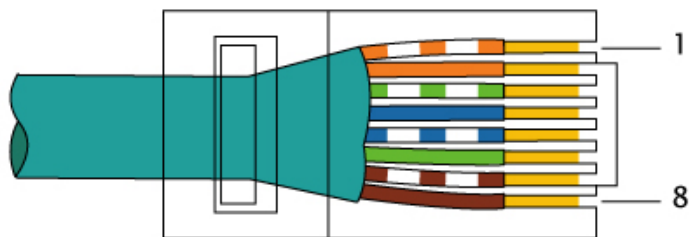

EIA/TIA-568B



Notes



Notes



Avenview Warranty Certificate

AVENVIEW CORP. ("Avenview") warrants Avenview-branded product(s) contained in the original packaging against defects in materials and workmanship when used normally in accordance with Avenview's enclosed manual guidelines for a period of THREE (3) YEARS from the date of original retail purchase - Warranty Period. Avenview's published guidelines include but are not limited to information contained in technical specifications, user manuals and service communications.

LABOR: During the Warranty Period of THREE (3) YEARS, Avenview will repair or replace the product(s) at no cost using new or used parts equivalent to novel performance and reliability if the product(s) is determined to have abide by Avenview's published guidelines. Cost of Labor applicable to product(s) after Warranty Period. For labor costs, please contact support@avenview.com.

PARTS: During the Warranty Period of THREE (3) YEARS, Avenview will supply new or rebuilt replacements in exchange for defective parts of the product(s) at no cost if the product(s) is determined to have abide by Avenview's published guidelines. Cost of Parts applicable to product(s) after Warranty Period. For part(s) costs, please contact support@avenview.com.

To obtain Warranty: (a) proof of purchase in the form of a bill of sale or receipted invoice reflecting that the registered product(s) is within warranty period must be presented to obtain warranty service; (b) product(s) must be registered at time of purchase. Failure to do so will result in applicable parts and labor charges. Returning product(s) must be shipped in Avenview's original packaging or in packaging pertaining equal degree of protection to Avenview's. Both Avenview and purchaser are responsible for freight charges and brokerages when shipping the product(s) to the receiver.

NOT COVERED BY THIS WARRANTY

This warranty does not apply to any non-Avenview branded product(s); non-registered Avenview product(s). This warranty does not apply: (a) to cosmetic damage, including but not limited to scratches, dents and broken cords; (b) to damage caused by use with another product; (c) to damage caused by accident, abuse, misuse, liquid contact, fire, earthquake or other external cause; (d) to damage caused by operating the Avenview product(s) outside Avenview's manuals or guidelines; (e) to damage caused by service performed by anyone who is not a representative of Avenview or an Avenview authorized personnel; (f) to defects caused by normal wear and tear or otherwise due to the normal aging of the Avenview product(s), or (g) if any serial number has been removed or defaced from the Avenview product(s).

AVENVIEW IS NOT LIABLE FOR DIRECT, SPECIAL, INCIDENTAL OR CONSEQUENTIAL DAMAGES RESULTING FROM ANY BREACH OF WARRANTY OR CONDITION, OR UNDER ANY OTHER LEGAL THEORY, INCLUDING BUT NOT LIMITED TO LOSS OF USE; LOSS OF REVENUE; LOSS OF ACTUAL OR ANTICIPATED PROFITS (INCLUDING LOSS OF PROFITS ON CONTRACTS); LOSS OF THE USE OF MONEY; LOSS OF ANTICIPATED SAVINGS; LOSS OF BUSINESS; LOSS OF OPPORTUNITY; LOSS OF GOODWILL; LOSS OF REPUTATION; LOSS OF, DAMAGE TO, COMPROMISE OR CORRUPTION OF DATA; OR ANY INDIRECT OR CONSEQUENTIAL LOSS OR DAMAGE REPAIR OR REPLACEMENT AS PROVIDED UNDER THIS WARRANTY IS THE EXCLUSIVE REMEDY OF THE CONSUMER.

Some states do not allow the inclusion or limitation of incidental or consequential damages, or allow limitations on duration implements of the Warranty Period; therefore the above limitations or exclusions may not be applicable to you. This warranty gives you specific legal rights, and you may have other rights which vary from state to state.



275 Woodward Avenue, Kenmore, NY 14217
1.866.508.0269





AV Connectivity, Distribution And Beyond...

TECHNICAL SUPPORT

CONTACT US



Phone: 1 (866) 508 0269



Email: support@avenview.com



USA Head Office Avenview Corp. 275 Woodward Avenue Kenmore, NY 14217

USA Head Office

Office Avenview
Corp. 275 Woodward Avenue
Kenmore, NY 14217
Phone: +1.716.218.4100 ext223
Fax: +1.866.387-8764
Email: info@avenview.com

Canada Sales

Avenview
151 Esna Park Drive, Unit 11 & 12
Markham, Ontario, L3R 3B1
Phone: 1.905.907.0525
Fax: 1.866.387.8764
Email: info@avenview.com

Avenview Europe

Avenview Europe
Demkaweg 11
3555 HW Utrecht
Netherlands
Phone: +31 (0)85 2100- 613
Email: info@avenview.eu

Avenview Hong Kong

Unit 8, 6/F, Kwai Cheong Centre,
50 Kwai Cheong Road,
Kwai Chung, N.T.
Hong Kong
Phone: 852-3575 9585
Email: wenxi@avenview.com

Disclaimer

While every precaution has been taken in the preparation of this document, Avenview Inc. assumes no liability with respect to the operation or use of Avenview hardware, software or other products and documentation described herein, for any act or omission of Avenview concerning such products or this documentation, for any interruption of service, loss or interruption of business, loss of anticipatory profits, or for punitive, incidental or consequential damages in connection with the furnishing, performance, or use of the Avenview hardware, software, or other products and documentation provided herein.

Avenview Inc. reserves the right to make changes without further notice to a product or system described herein to improve reliability, function or design. With respect to Avenview products which this document relates, Avenview disclaims all express or implied warranties regarding such products, including but not limited to, the implied warranties of merchantability, fitness for a particular purpose, and non-infringement.